

components | accessories



IT nelle pagine seguenti troverete tutti gli accessori necessari quali profili, connettori, angolari, piedini di appoggio, ruote e basi per la libera composizione della vostra personalissima struttura soistes. nell'ultima parte di questa sezione troverete inoltre la gamma completa di ripiani, scaffali, portaoggetti, portaposter e sistemi di fissaggio a disposizione per il completamento delle vostre creazioni con soistes.

DE auf den folgenden seiten finden sie alle erforderlichen profile, eckverbinder, füsse, rollen und basen für den bau ihrer ganz persönlichen soistes-struktur. und im letzten teil gibt es alle ablagen, fachböden, objektträger, postertaschen und die erforderlichen befestigungen für sie zur auswahl.

EN on the following pages you find all the single components such as extrusions, edge connectors, feet, wheels and bases to set up your very own soistes structure. and in the last chapter you find a large variety of shelves, boards, trays, poster pockets and the required mounting supports for you to choose from.



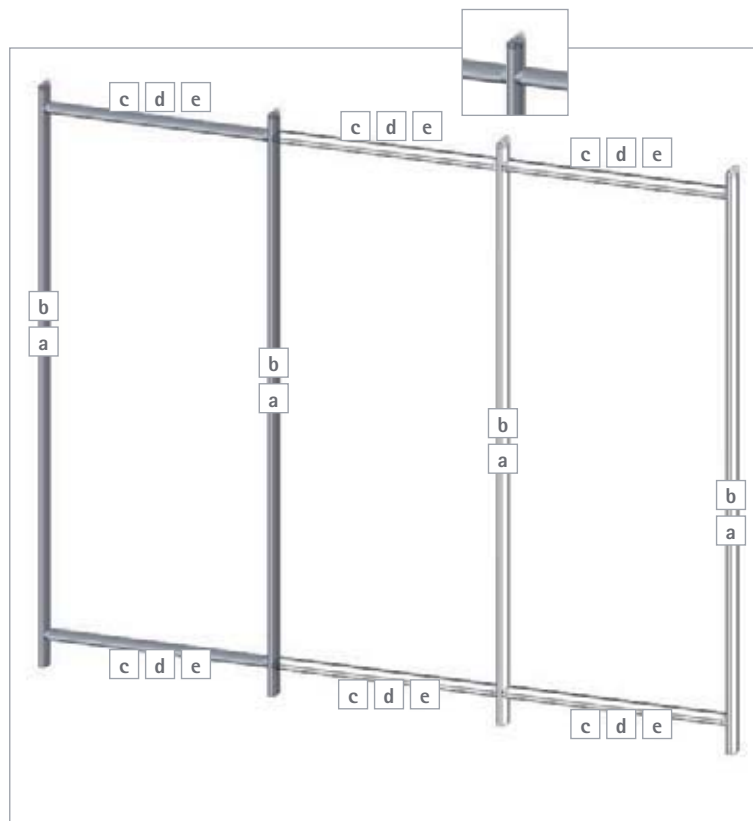
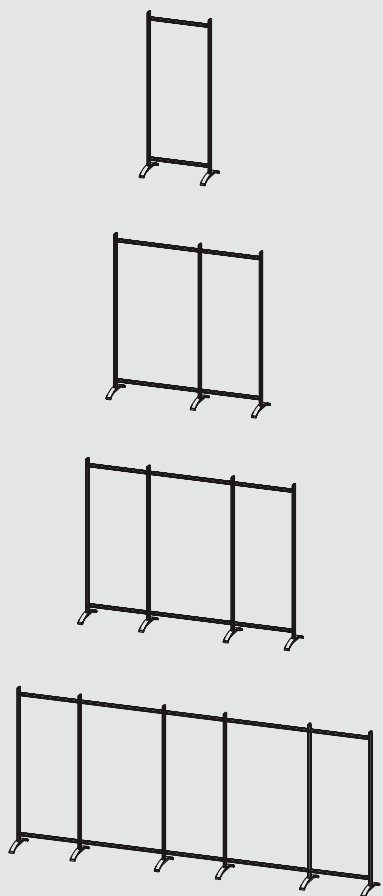

frameA

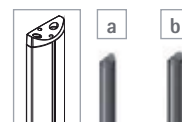

1900mm

1700mm



c 640mm

d 900mm

e 1500mm

IT grazie a questi moduli pre-assemblati di o-profili con connettori, le creazioni ed il montaggio di una struttura base soistes sono davvero semplici e veloci: basta scegliere l'altezza e la larghezza desiderata e il tipo di angolare in alto (frame A: terminale ad angolo retto e frame B: a traversa).

DE mit diesen bereits abgelängten und mit verbindern vormontierten profil-O-modulen ist der aufbau der soistes grundstruktur ganz unkompliziert: einfach gewünschte höhe und breite sowie art des oberen eck-abschlusses (frame A überstehend, frame B bündig) auswählen.

EN with these pre-cut extrusion modules and with connectors pre-assembled, the set up of the soistes basic structure is really convenient and easy: just choose the required height and width and which kind of corner connection (frame A overlying, frame B flush).

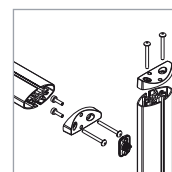

a	SOFA1900V	frameA V 1900mm, 1pc	
b	SOFA1700V	frameA V 1700mm, 1pc	
c	SOFAB640Q	frameA/B Q 640mm, 1pc	
d	SOFAB900Q	frameA/B Q 900mm, 1pc	
e	SOFAB1500Q	frameA/B Q 1500mm, 1pc	

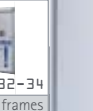
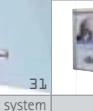
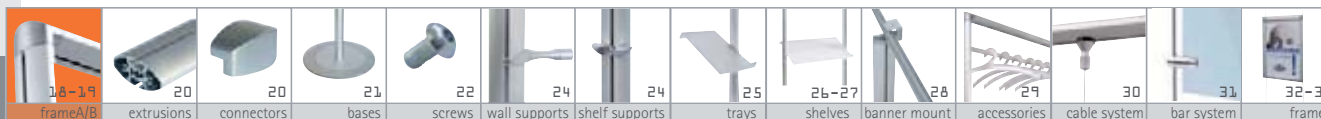

frameB



c	SOFAB640Q	frameA/B Q 640mm, 1pc	
d	SOFAB900Q	frameA/B Q 900mm, 1pc	
e	SOFAB1500Q	frameA/B Q 1500mm, 1pc	
f	SOFB1900VE	frameB VE 1900mm, 1pc	
g	SOFB1700VE	frameB VE 1700mm, 1pc	
h	SOFB1900VM	frameB VM 1900mm, 1pc	
i	SOFB1700VM	frameB VM 1700mm, 1pc	
j	SOFB640Q	frameB Q 640mm, 1pc	
k	SOFB900Q	frameB Q 900mm, 1pc	
l	SOFB1500Q	frameB Q 1500mm, 1pc	

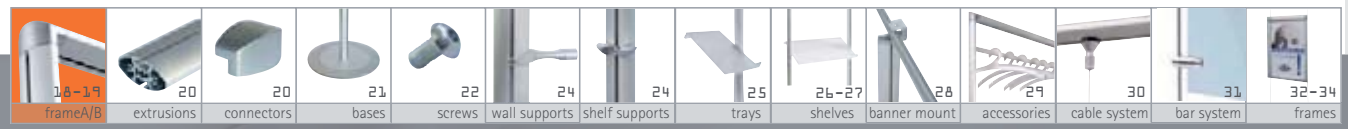
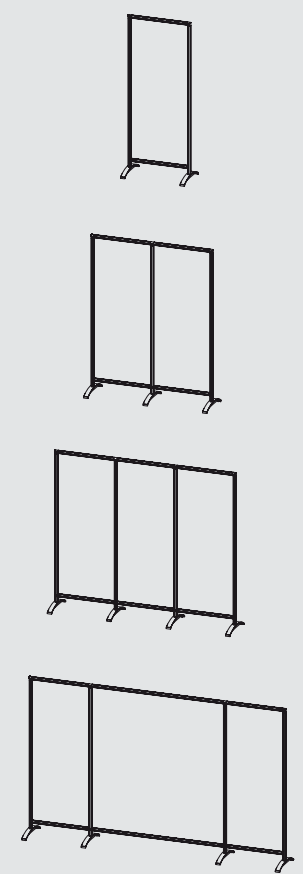
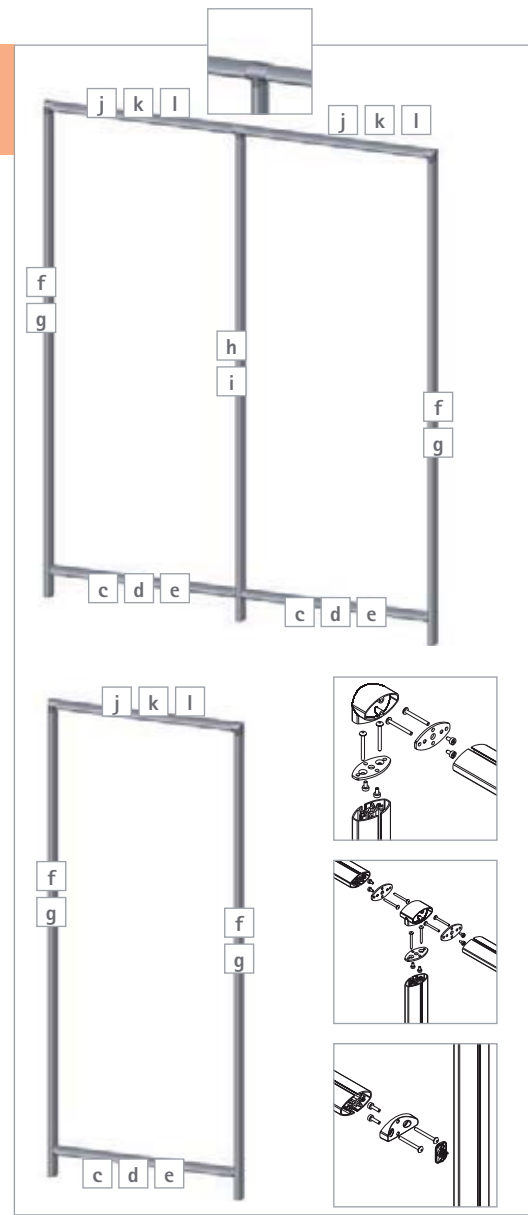

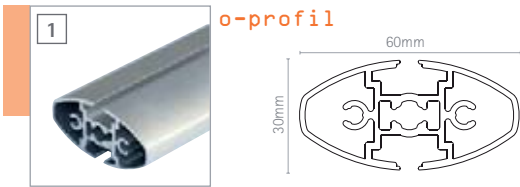

o-profil

IT o-profil , 25 barre da 5,9m, alluminio anodizzato color argento
DE o-profil 25 stangen zu je 5,9m silber eloxiertes aluminium
EN o-profil 25 bars each 5.9m, silver anodised aluminium

1 **S00P25X5900** 25x5900mm

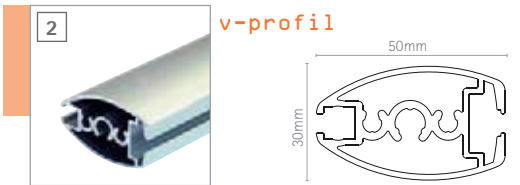

v-profil

IT v-profil, 25 barre da 6,1m; per connessione orizzontale tra profili ovali, alluminio anodizzato color argento
DE v-profil 25 stangen zu je 6,1m für querverbindung zwischen o-profilen, zum selbstablängen, alu silber eloxiert
EN v-profil 25 bars each 6.1m, horizontal connectors for o-profiles, silver anodised aluminium

2 **S0VP25X6100** 25x6100mm



deco

IT profiloletto interno decorativo di copertura, 20 barre da 2950mm, alluminio anodizzato color argento
DE dekorschiene für das abdecken der nut, 20 stangen à 2950mm, silber eloxiertes aluminium
EN decorative bar to cover the profile's slot, 20 bars each 2950mm, silver anodized aluminium

3 **S0DC20X2950** 20x2950mm

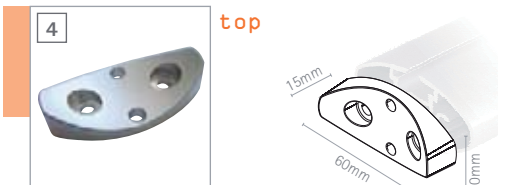

top

IT terminale per profili o connettore realizzato in metallo a pressofusione
DE profilabschluss oder verbinder, aus versilbertem metall-druckguss
EN extrusion tailpiece or connector, silver-plated metal die-cast

4 **S0TP6030AR** box 20pcs

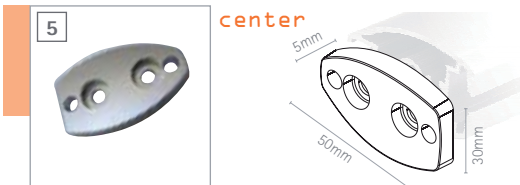

center

IT connettore per profili realizzato in metallo a pressofusione
DE verbinder für v-profil, aus versilbertem metall-druckguss
EN v-profil connector, silver-plated metal die-cast

5 **S0CT5030AR** box 20pcs

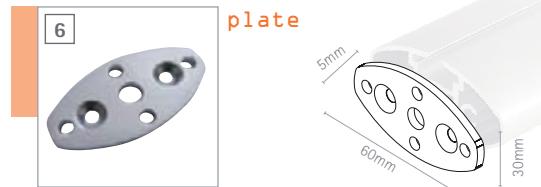

plate

IT connettore per profili realizzato in metallo a pressofusione e con nichelatura brillante
DE adapter verbinder und profil, metalldruckguss glanz-vernickelt
EN adapter connector and extrusion, polished nickel-plated metal die-cast

6 **S0PL6030NI** box 20pcs

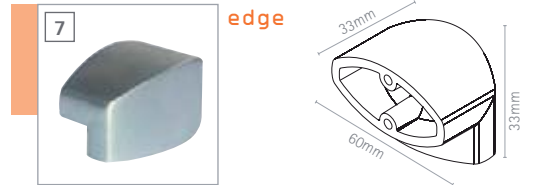

edge

IT angolare realizzato in metallo a pressofusione, color argento
DE eckverbinder, metalldruckguss versilbert
EN corner connector, silver-plated metal die-cast

7 **S0ED6033AR** box 8pcs



corner

IT angolare realizzato in metallo a pressofusione, color argento
DE eckverbinder, metalldruckguss versilbert
EN corner connector, silver-plated metal die-cast

8 **S0C03063AR** box 8pcs

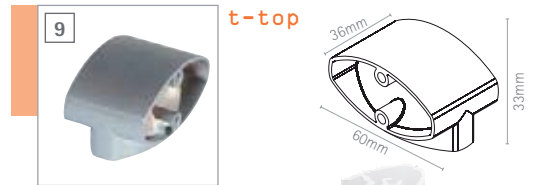

t-top

IT connettore a T realizzato in metallo a pressofusione, color argento
DE t-verbinder, metalldruckguss versilbert
EN t-joint, silver-plated metal die-cast

9 **S0TT6036AR** box 8pcs



t-con

IT connettore a traversa realizzato in metallo a pressofusione, color argento
DE profilverbinder, metalldruckguss versilbert
EN extrusion connector, silver-plated metal die-cast

10 **S0TC3642AR** box 20pcs

start june 2009

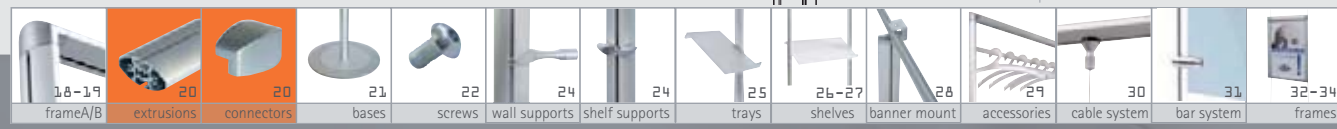
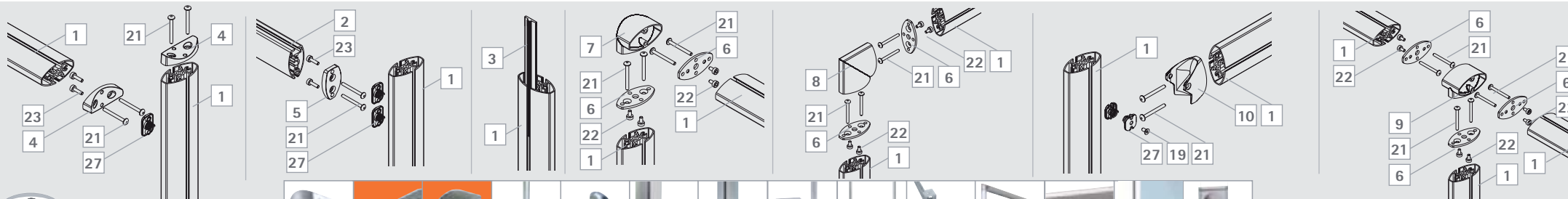

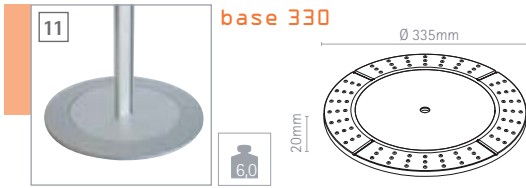

base 330

IT base con rivestimento esterno di protezione in ABS, color argento, inserto decorativo in alluminio anodizzato, color argento
DE versilberter abs-trittschutzring mit silber eloxierter aluminium-dekorscheibe
EN silver-plated abs-step-on-protection ring with silver anodised aluminium decorative inlay

11 SOBS330AR 1pc

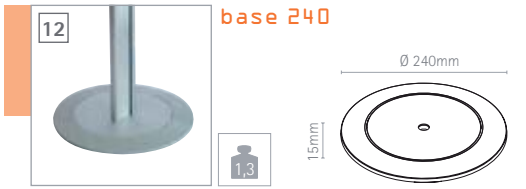

base 240

IT base con rivestimento esterno di protezione in ABS colore grigio, inserto decorativo in alluminio anodizzato, color argento
DE grauer abs-trittschutz-ring mit silber eloxierter aluminium dekor-scheibe
EN grey abs-step-on-protection ring with silver anodised aluminium decorative inlay

12 SOBS240 1pc

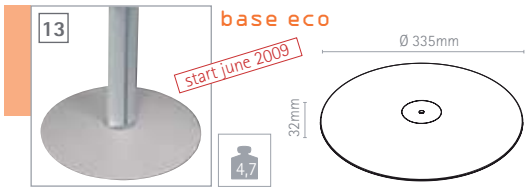

base eco

IT base in abs, grigio luce
DE lichtgraue abs-kunststoff-basis
EN light-grey synthetic base

13 SOEB330GR 1pc

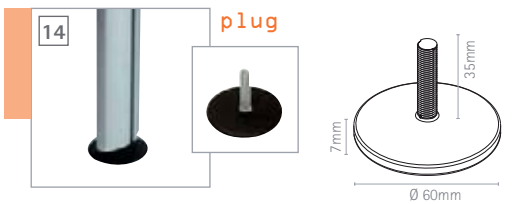

plug

IT piedini di appoggio in gomma rigida, nera, con perno filettato
DE hartgummi-fuss, schwarz mit gewinde
EN hard rubber foot, black with thread

14 SOPU60SZ box 4pcs

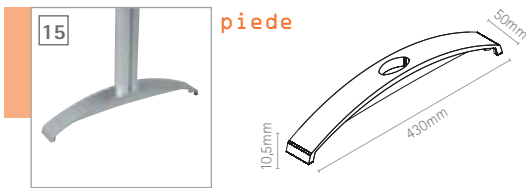

piede

IT base realizzata in metallo a pressofusione color argento, con appoggi antiscivolo, colore nero
DE fuss aus versilbertem metall-druckguss, mit schwarzen anti-rutsch pads aus kunststoff
EN foot made of silver-plated metal die-cast, with black anti-slip pads

15 SOPI430AR 1pc



roller

IT ruota doppia nera in PA ricoperta in TPU, per montaggio con base piede (2pz cad)
DE leichtlaufrollen aus PA schwarz mit TPU auflage, zur montage auf fuss piede (je 2stück)
EN smooth wheels in black PA with TPU overlay, for mounting to the base piede (2pcs each)

16 SOR035 box 4pcs



pad

IT piedini di appoggio in gomma rigida nera con perno filettato, per il montaggio con la base piede (2pz cad)
DE hartgummi-fuss schwarz, zur montage auf fuss piede (je 2stück)
EN hard rubber foot, black, for mounting to the base piede (2pcs each)

17 SOPD40SZ box 4pcs

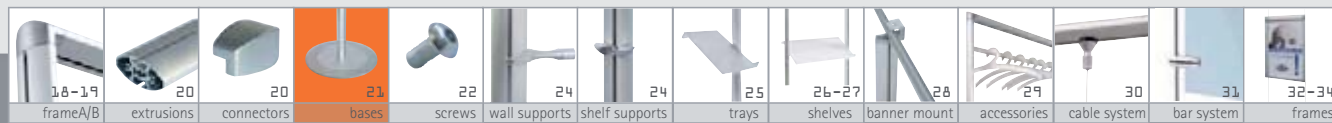
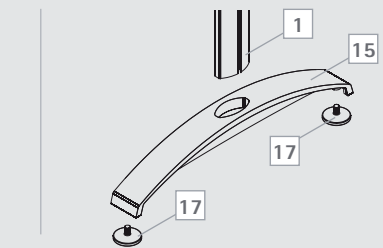
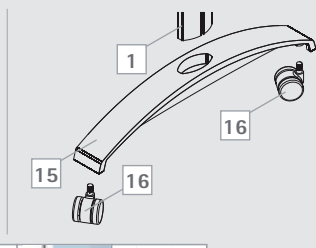
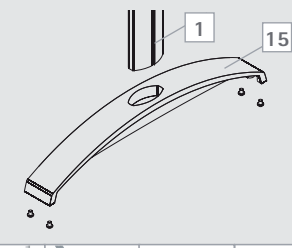
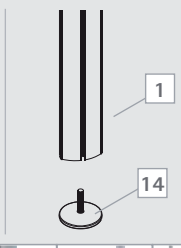
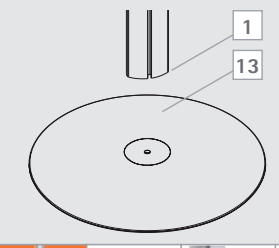
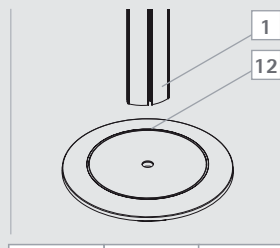
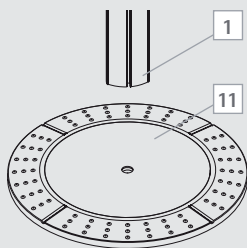

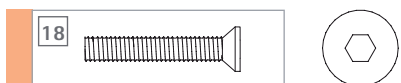

M5x35 3mm hex key

18 SOVIM5X35 box 500pcs

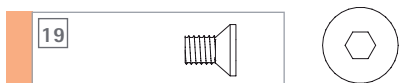

M5x10 3mm hex key

19 SOVIM5X10 box 500pcs



M5x45 4mm hex key

20 SOVIM5X45 box 500pcs



M5x40 lens head 3 mm hex screw

21 SOVIM5X40 box 200pcs

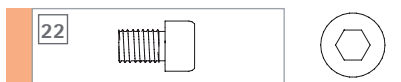

M5x8 cylinder head 4mm hex screw

22 SOVIM5X8 box 500pcs

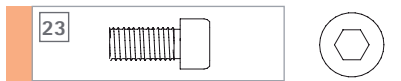

M5x12 cylinder head 4mm hex screw

23 SOVIM5X12 box 500pcs

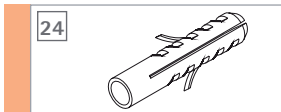

anchor 8x40

24 SOTA8L40 box 100pcs



ballpoint hex key 4mm, T-handle

25 SOKEY4 1pc

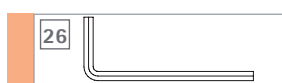

hex key 3mm

26 INBUS3 box 100pcs



IT dado quadro con molla
DE vierkantmutter mit feder
EN square nut with spring

27 SODD3FS06 box 10pcs



IT dado quadro con molla
DE vierkantmutter mit feder
EN square nut with spring

28 SODD2FS07 box 10 pcs



IT dado ad incastro, per montare pannelli leggeri con viti autofilettanti
DE einklickmutter, für montage leichter paneele mit blechschrauben
EN nut, to mount lightweight panels with self tapping screws

29 SODD1010SY box 100pcs

